

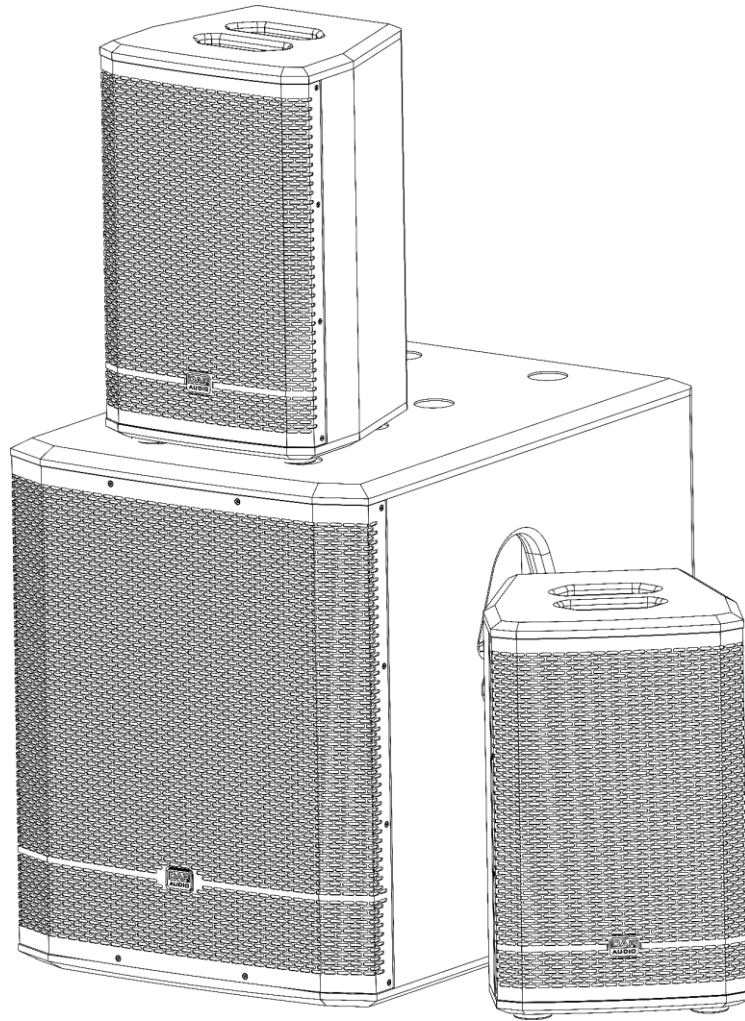

MANUAL



ENGLISH

Pure Club 15 with DSP

V1

Order code: D3761

Table of contents

Warning2
 Safety Instructions2
 Operating Determinations4
 Connection with the mains.....4
 Return Procedure.....4
 Claims.....4

Description of the device.....5
 Overview6
 Subwoofer7
 Satellite.....8

Installation.....8

Setup and Operation9
 Connection Example9
 Control Panel.....10
 Main Menu Options10
 1. Mode.....11
 2. Preset.....11
 3. Low EQ.....11
 4. Mid EQ11
 5. High EQ12
 6. Sub Adjust.....12
 7. Sub Phase.....12
 8. System Delay12
 9. Limit13
 10. Contrast.....13
 11. Sleep Mode13
 12. Lock.....13
 13. Password Set.....14
 14. Name Set14
 15. Set Logo.....14
 16. Store15
 17. Recall15
 18. Reset.....16
 19. Info.....16
 20. Exit.....16

Connection Cables.....17

Maintenance.....18
 Replacing the Fuse18

Troubleshooting19
 No Sound19
 Sound Warping.....19

Product Specifications.....20

Notes.....21

Warning



**For your own safety, please read this user manual carefully
before your initial start-up!**



Unpacking Instructions

Immediately upon receiving this product, carefully unpack the carton and check the contents to ensure that all parts are present, and have been received in good condition. Notify the dealer immediately and retain packing material for inspection if any parts appear damaged from shipping or the carton itself shows signs of mishandling. Save the carton and all packing materials. In the event that a fixture must be returned to the factory, it is important that the fixture be returned in the original factory box and packing.

Your shipment includes:

- DAP Audio Pure Club 15 with DSP
- User manual

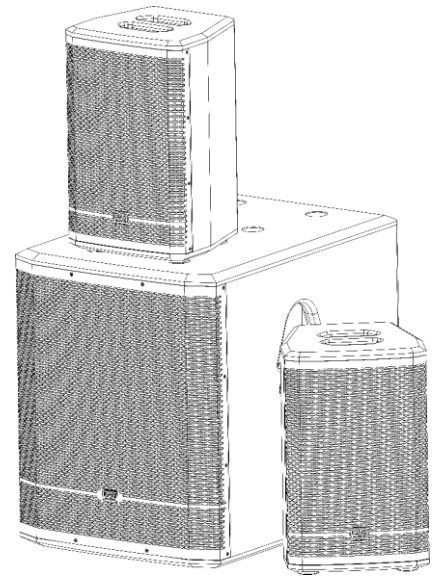

CAUTION!
Keep this device away from rain and moisture!
Unplug mains lead before opening the housing!



Safety Instructions

Every person involved with the installation, operation and maintenance of this system has to:

- be qualified
- follow the instructions of this manual



CAUTION! Be careful with your operations.
**With a dangerous voltage you can suffer
a dangerous electric shock when touching the wires!**



Before your initial start-up, please make sure that there is no damage caused by transportation. Should there be any, consult your dealer and do not use the system.

To maintain perfect condition and to ensure a safe operation, it is absolutely necessary for the user to follow the safety instructions and warning notes written in this manual.

Please consider that damages caused by manual modifications to the system are not subject to warranty.

This system contains no user-serviceable parts. Refer servicing to qualified technicians only.

IMPORTANT:

The manufacturer will not accept liability for any resulting damages caused by the non-observance of this manual or any unauthorized modification to the system.

- Always disconnect power from the mains, when system is not used. Only handle the power cord by the plug. Never pull out the plug by tugging the power cord.
- Always operate the unit with the AC ground wire connected to the electrical system ground.
- Avoid flames and do not put close to flammable liquids or gases.
- Avoid ground loops! Always be sure to connect the power amps and the mixing console to the same electrical circuit to ensure the same phase!
- Avoid installing your equipment very near radio or TV sets, mobile phones, etc., as these can cause RF (radio frequency) interference.
- Avoid loud feedback from microphones. This can damage your speaker.
- Before changing your grounds around, always turn your amplifiers down.
- Do not connect this device to a dimmer pack.
- Do not drive the inputs with a signal level higher than required to drive the equipment to full output.
- Do not open this device. Risk: hazardous radiation exposure.
- Do not open the device and do not modify the device.
- Do not switch the system on and off in short intervals, as this would reduce the system's life.
- Extreme frequency boosts in connection with a high input signal level may lead to overdriving your equipment. Should this occur, it is necessary to reduce the input signal level by using the INPUT control.
- For replacement use fuses of same type and rating only.
- If device is dropped or struck, disconnect mains power supply immediately. Have a qualified engineer inspect for safety before operating.
- If the system has been exposed to drastic temperature fluctuation (e.g. after transportation), do not switch it on immediately. The arising condensation water might damage your system. Leave the system switched off until it has reached room temperature.
- If your DAP Audio device fails to work properly, discontinue use immediately. Pack the unit securely (preferably in the original packing material), and return it to your DAP Audio dealer for service.
- Make sure that the available voltage is not higher than stated on the rear panel.
- Make sure that the power cord is never crimped or damaged. Check the device and the power cord from time to time.
- Make sure that the signals into the mixer are balanced, otherwise hum could be created.
- Make sure that there is sufficient room on all sides of the system for air circulation.
- Make sure you do not use the wrong kind of cables or defective cables.
- Make sure you use DI boxes to balance unbalanced signals; All incoming signals should be clear.
- Never let the power cord come into contact with other cables! Handle the power cord and all connections with the mains with particular caution!
- Never remove warning or informative labels from the unit.
- Never modify, bend, mechanically strain, put pressure on, pull or heat up the power cord.
- Never use anything to cover the ground contact.
- Never use the device during thunderstorms, unplug the device immediately.
- Only use device indoors, avoid contact with water or other liquids.
- Prevent distortion! Make sure that all components connected to the Pure Club have sufficient power ratings. Otherwise distortion will be generated because the components are operated at their limits.
- Repairs, servicing and electric connection must be carried out by a qualified technician.
- The best way (even if not always feasible) to avoid ground loops is to connect the electric ground of all the equipment to a single central point ("star" system). In this case, the central point can be the mixer.
- To avoid or solve hum and buzzing troubles, try different combinations of lifting grounds on units that are supplied with ground lift switches or make sure all chassis are connected to earth ground, either through the A.C. power cord ground or by the front panel rack mount screws.
- To emphasize a frequency range, you do not necessarily have to move its respective slider upwards; instead, try lowering surrounding frequency ranges. This way, you avoid causing the next piece of equipment in your sound path to overdrive. You also preserve valuable dynamic reserve ("headroom").
- The user is responsible for correct positioning and operating of this product. The manufacturer will not accept liability for damages caused by the misuse or incorrect installation of this device.
- When connecting the other parts of your sound system, watch out for the so-called "ground loops".
- Please read this manual carefully and keep it for future reference.
- WARRANTY: Till one year after date of purchase.

Operating Determinations

This system is not designed for permanent operation. Consistent operation breaks will ensure that the system will serve you for a long time without defects.

If this system is operated in any other way than the one described in this manual, the product may suffer damages and the warranty becomes void.

Any other operation may lead to dangers like short-circuit, burns, electric shock, etc.

You endanger your own safety and the safety of others!

Improper installation can cause serious injuries and damage of property!

Connection with the mains

Connect the device to the mains with the power-plug.

Always pay attention, that the right color cable is connected to the right place.

International	EU Cable	UK Cable	US Cable	Pin
L	BROWN	RED	YELLOW/COPPER	PHASE
N	BLUE	BLACK	SILVER	NEUTRAL
	YELLOW/GREEN	GREEN	GREEN	PROTECTIVE GROUND

Make sure that the device is always connected properly to the earth!

Improper installation can cause serious damage to people and property!

 **Return Procedure** 

Returned merchandise must be sent prepaid and in the original packing, call tags will not be issued. Package must be clearly labeled with a Return Authorization Number (RMA number). Products returned without an RMA number will be refused. Highlite will not accept the returned goods or any responsibility. Call Highlite 0031-455667723 or mail aftersales@highlite.com and request an RMA prior to shipping the fixture. Be prepared to provide the model number, serial number and a brief description of the cause for the return. Be sure to properly pack fixture, any shipping damage resulting from inadequate packaging is the customer's responsibility. Highlite reserves the right to use its own discretion to repair or replace product(s). As a suggestion, proper UPS packing or double-boxing is always a safe method to use.

Note: If you are given an RMA number, please include the following information on a piece of paper inside the box:

- 01) Your name
- 02) Your address
- 03) Your phone number
- 04) A brief description of the symptoms

Claims

The client has the obligation to check the delivered goods immediately upon delivery for any short-comings and/or visible defects, or perform this check after our announcement that the goods are at their disposal. Damage incurred in shipping is the responsibility of the shipper; therefore the damage must be reported to the carrier upon receipt of merchandise.

It is the customer's responsibility to notify and submit claims with the shipper in the event that a fixture is damaged due to shipping. Transportation damage has to be reported to us within one day after receipt of the delivery.

Any return shipment has to be made post-paid at all times. Return shipments must be accompanied with a letter defining the reason for return shipment. Non-prepaid return shipments will be refused, unless otherwise agreed in writing.

Complaints against us must be made known in writing or by fax within 10 working days after receipt of the invoice. After this period complaints will not be handled anymore.

Complaints will only then be considered if the client has so far complied with all parts of the agreement, regardless of the agreement of which the obligation is resulting.

Description of the device

Features

The Pure Club 15 with DSP consists of a 15" subwoofer and two 8"/1" satellites. The satellites are equipped with neodymium high drivers and a special wave guide for frequencies up to 20 kHz. Due to the 8" mid speakers, this set has a more detailed natural sound quality. The built-in DSP processor will protect the system and speaker drivers against overload and will give an excellent frequency response at any sound pressure level. The set is finished with scratch resistant paint and stylish metal grills.

- Power supply: 120/230 V AC, 50/60 Hz
- Power amp low: 400 W RMS @ 8 Ω
- Power amp high: 2 x 150 W RMS @ 8 Ω
- Speaker low: 15", 2" Voice coil
- Speaker high: 8"/1" passive vented PA Satellite speaker system
- Frequency response (-3 dB): 40 Hz–20 kHz
- S/N ratio: >103 dB
- Crossover frequency: 125 Hz, 24 dB/Oct BW
- Dispersion satellite (HxV): 90° x 60°
- Dispersion subwoofer (HxV): 360° x 180°
- Sensitivity satellite (full space): 95 dB / W / m
- Sensitivity subwoofer (half space): 102 dB / W / m
- SPL peak satellite @ 1 m: 116,8 dB
- SPL peak subwoofer @ 1 m: 128 dB
- Protection: Short circuit, temperature, overload
- Audio connector: 2 x combo 3-pin XLR/6,3 mm jack IN; 2 x 3-pin XLR OUT; 2 x Speakon NL4 OUT; RCA L/R IN
- Mains connector: Pro power connector IN/OUT
- Housing: 12-mm Birch Plywood
- Color: Black, scratch resistant
- Mounting: 35-mm pole mount
- Fuse (subwoofer): T5AL/250V
- Dimensions (satellite): 265 x 250 x 420 mm (LxWxH)
- Dimensions (subwoofer): 625 x 454 x 570 mm (LxWxH)
- Weight (satellite): 2 x 6,88 kg
- Weight (subwoofer): 28,82 kg

Optional accessories

[D3719](#) – Pure-10A 10" Full Range Top Cabin

[D3720](#) – Pure-15A 15" Full Range Top Cabin

[D3721](#) – Pure-12A 12" Full Range Top Cabin

[D3725](#) – Pure-18AS 18" Subwoofer with DSP

[D3726](#) – Pure-15AS 15" Subwoofer with DSP

[D3740](#) – Pure-10 Passive 10" Full Range

[D3741](#) – Pure-12 Passive 12" Full Range

[D3742](#) – Pure-15 Passive 15" Full Range

[D3743](#) – Pure-15S Passive 15" Subwoofer

[D3744](#) – Pure-18S Passive 18" Subwoofer

[D3760](#) – Pure Club 12 excl DSP

D3763 – Pure Club 15 Speaker cover set

[D8600](#) – DAP Speaker Stand 35 mm

[FS143](#) – Neutrik Speakon > Speakon speaker cable, 4 x 2,5 mm² (3 m)

[FS146](#) – Neutrik Speakon > Speakon speaker cable, 4 x 2,5 mm² (6 m)

[FS1410](#) – Neutrik Speakon > Speakon speaker cable, 4 x 2,5 mm² (10 m)

[FS1415](#) – Neutrik Speakon > Speakon speaker cable, 4 x 2,5 mm² (15 m)

[FS1420](#) – Neutrik Speakon > Speakon speaker cable, 4 x 2,5 mm² (20 m)

[FS153](#) – Neutrik Speakon > Speakon speaker cable, 4 x 4 mm² (3 m)

[FS156](#) – Neutrik Speakon > Speakon speaker cable, 4 x 4 mm² (6 m)

[FS1510](#) – Neutrik Speakon > Speakon speaker cable, 4 x 4 mm² (10 m)

[FS1515](#) – Neutrik Speakon > Speakon speaker cable, 4 x 4 mm² (15 m)

[FS1520](#) – Neutrik Speakon > Speakon speaker cable, 4 x 4 mm² (20 m)

Overview

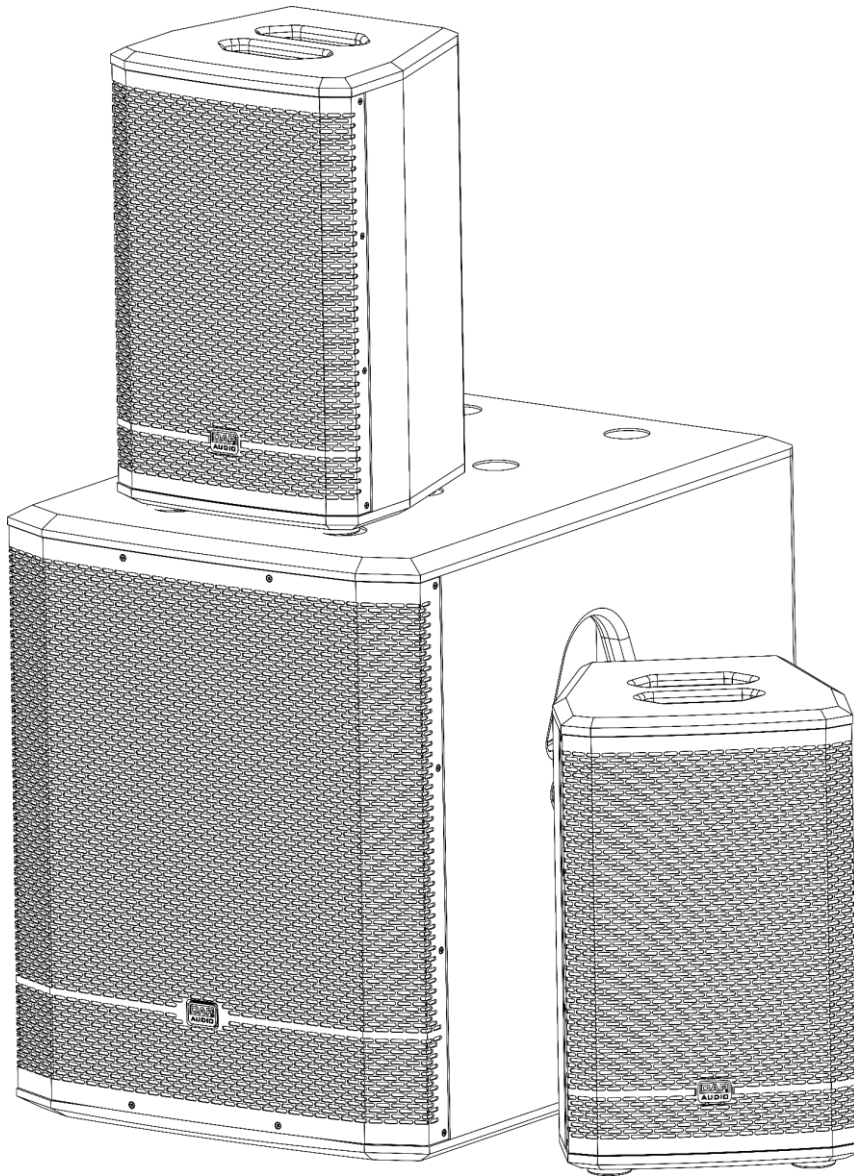

Fig. 01

Subwoofer

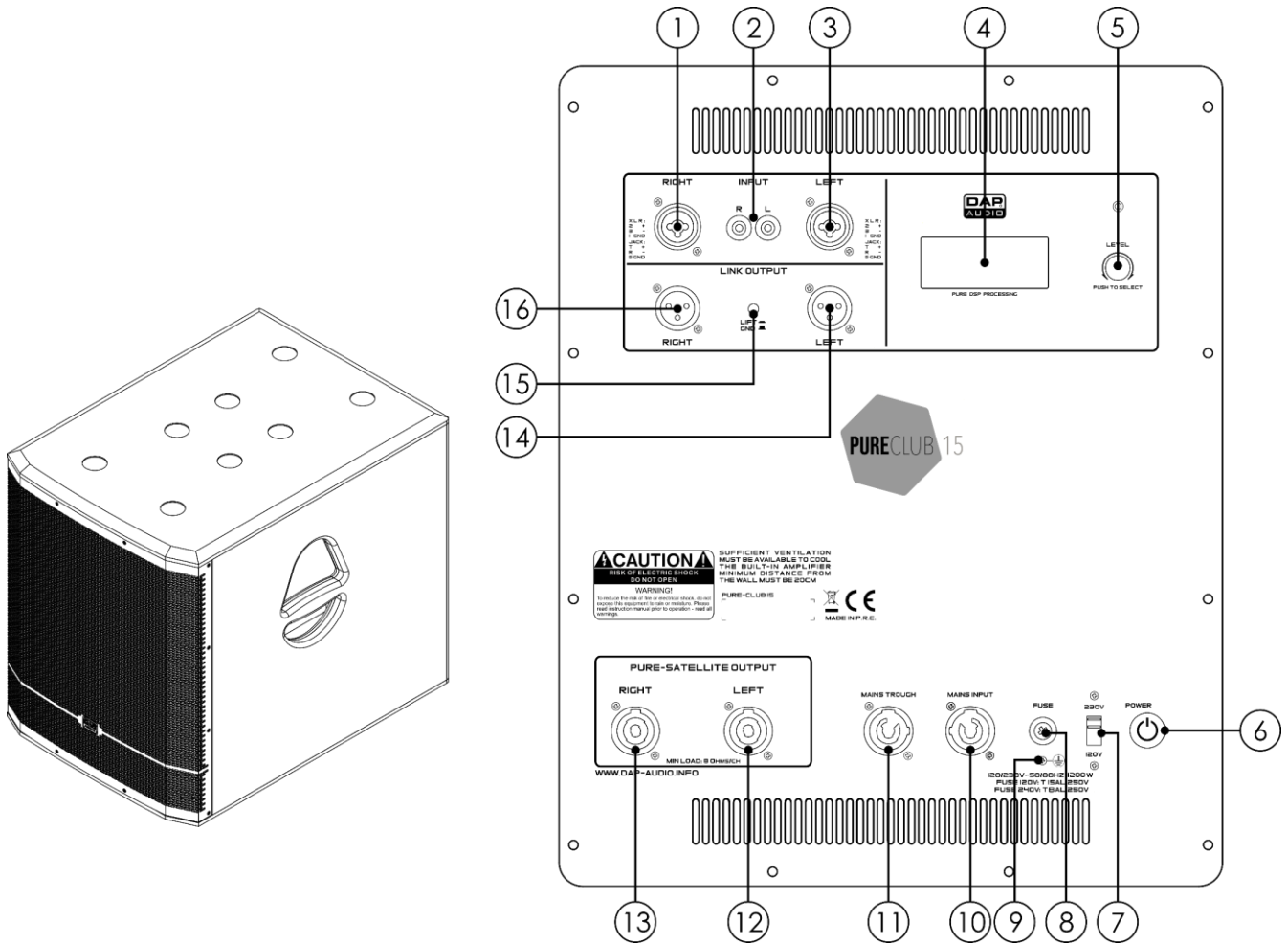

Fig. 02

- 01) **Combo 3-pin XLR/6,3 mm jack connector, RIGHT INPUT**
Connect a line level device or a microphone.
- 02) **RCA connector IN**
Connect a stereo line level source.
- 03) **Combo 3-pin XLR/6,3 mm jack connector, LEFT INPUT**
Connect a line level device or a microphone.
- 04) **LCD display**
- 05) **Menu control**
Turn/press the control to navigate through the main menu.
- 06) **Power switch ON/OFF**
- 07) **Voltage selector**
Move the switch to select the desired voltage, 120 V or 230 V.
Make sure that the available voltage is not higher/lower than the option selected with this switch.
- 08) **Fuse T5AL/250V**
- 09) **Ground/earth connection**
- 10) **Pro power connector (Blue) IN**
- 11) **Pro power connector (Gray) THROUGH**
- 12) **Speakon NL4 LEFT OUT**
Connect the included satellite cabinet.
- 13) **Speakon NL4 RIGHT OUT**
Connect the included satellite cabinet.
- 14) **3-pin XLR male connector, LEFT OUTPUT**
Line level balanced output for daisy chaining.
- 15) **LIFT/GND selector**
Press the button to eliminate unwanted hum or buzz, caused by ground loops.
- 16) **3-pin XLR male connector, RIGHT OUTPUT**
Line level balanced output for daisy chaining.

Satellite

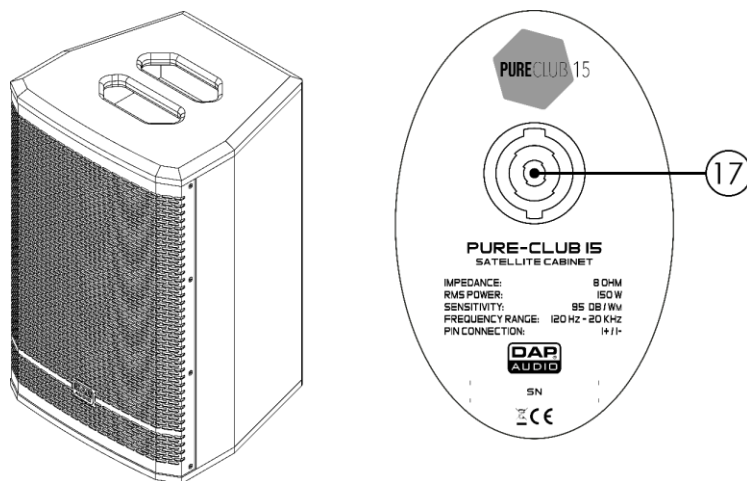

Fig. 03

17) **Speakon NL4 IN**

Connect the included subwoofer cabinet. (Pin connection: 1+, 1-)

Installation

Remove all packing materials from the Pure Club 15 with DSP. Check if all foam and plastic padding is removed. Connect all cables.

Do not supply power before the whole system is set up and connected properly.

Always disconnect from electric mains power supply before cleaning or servicing.

Damages caused by non-observance are not subject to warranty.

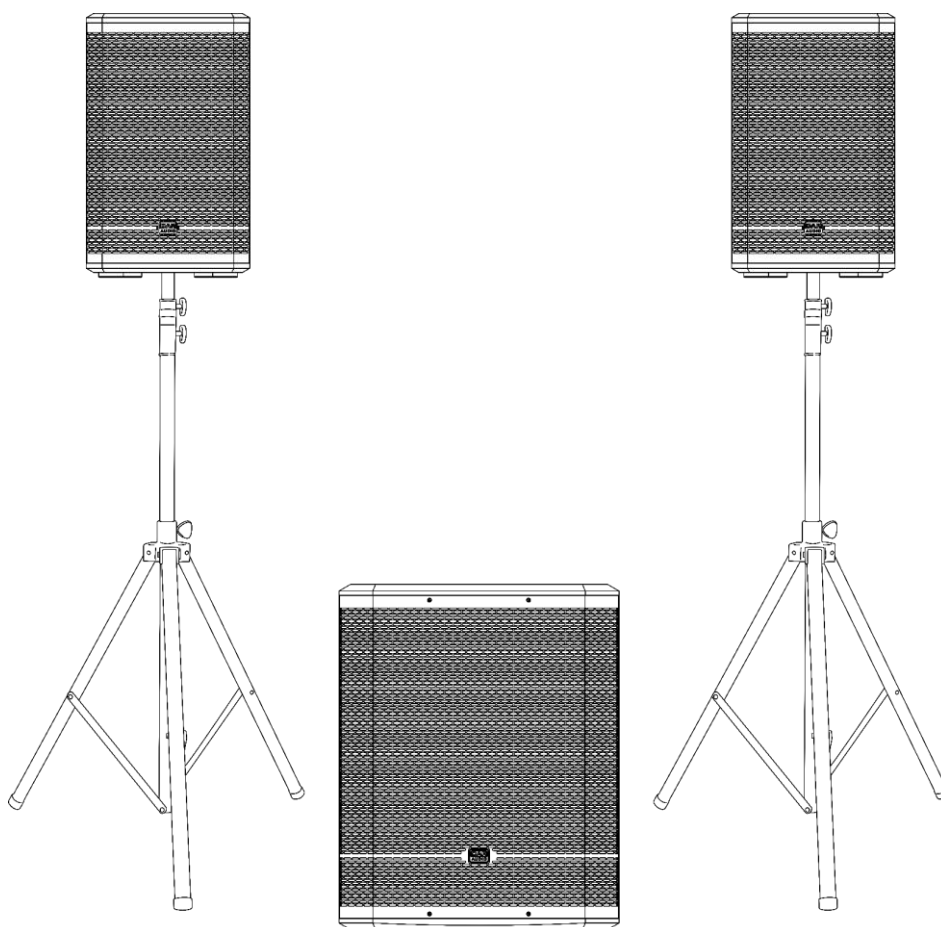

Fig. 04

Setup and Operation

Follow the directions below, as they pertain to your preferred operation mode. Before plugging the unit in, always make sure that the power supply matches the product specification voltage. Do not attempt to operate a 110 V specification product on 230 V power, or vice versa.

Connection Example

Make your initial connections with all the equipment powered off and ensure that all the main volume controls are turned completely to the minimum. Follow the steps below.

- 01) Connect the outputs on your mixer with the inputs on the subwoofer.
- 02) Connect the Speakon connectors on the subwoofer **(12/13)** with the input connectors on both satellites **(17)**.
- 03) Turn on your mixer first, then the speakers.
- 04) After using your equipment, turn off the Pure speakers first, then the mixer.

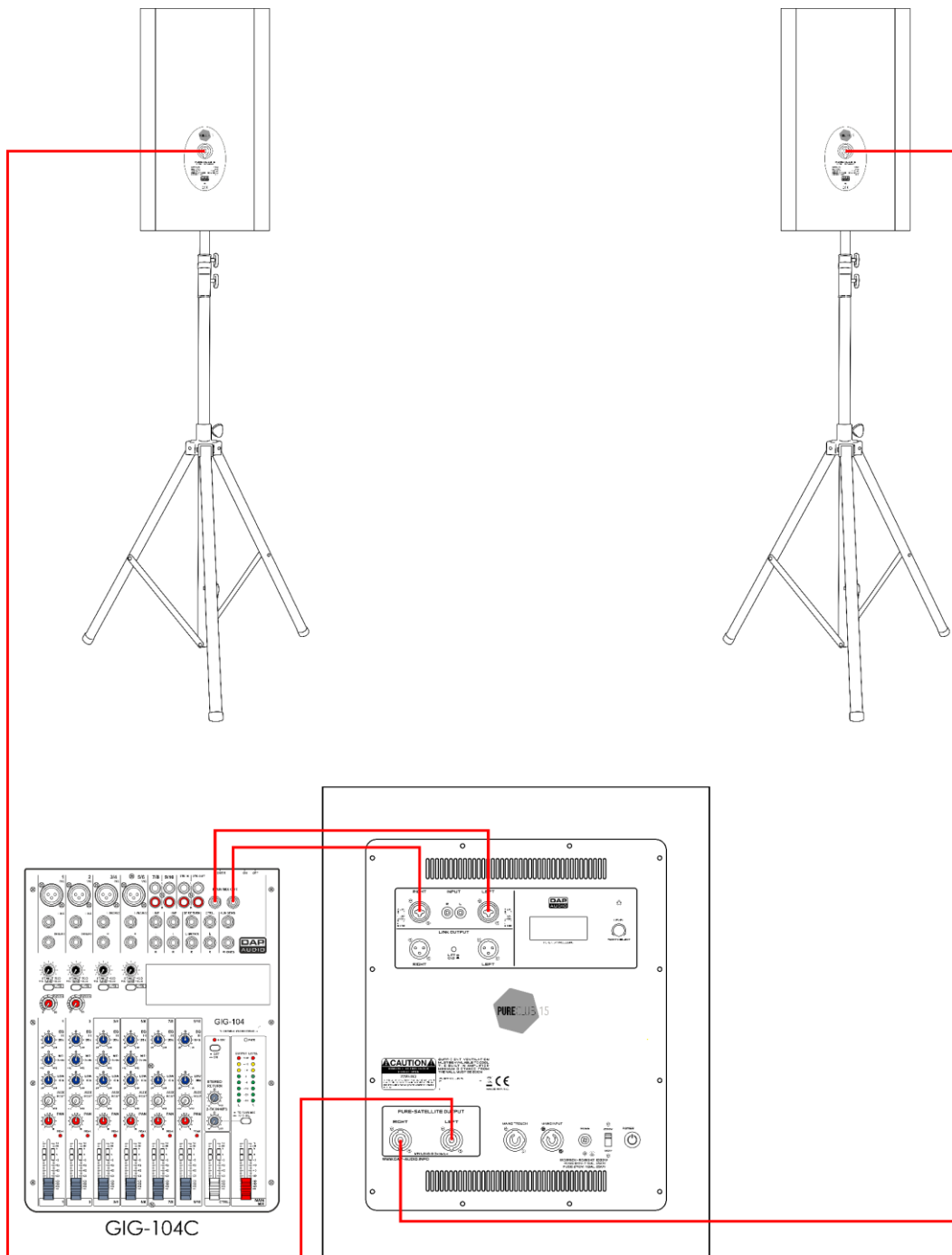
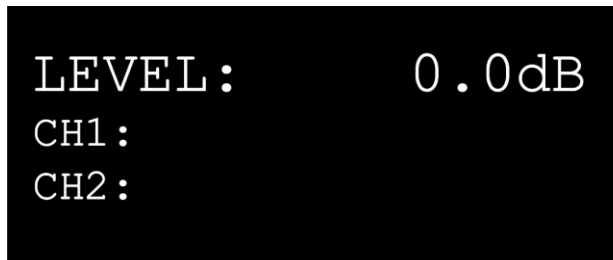

Fig. 05

Control Panel



PURE DSP PROCESSING



PUSH TO SELECT

Press and turn the control to navigate through the menu options.

Fig. 06

⚠ Display Off after 60 seconds ⚠

When the control (05) is neither pressed or turned for 60 seconds, the display will turn off. Once you have pressed or turned the control (05), the display will light up.

Main Menu Options

- 01) Upon start-up, the display will show a splash screen with the Pure Series logo.
- 02) 5 seconds later, the display will show the start screen:

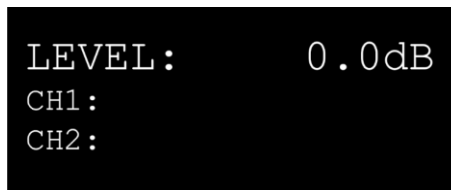

- LEVEL indicates the master signal level.
 - CH1 and CH2 indicate the current input signal level on the left and right input.
- 03) Turn the control (05) to set the level. The adjustment range is between -80 dB and 10 dB.
 - 04) Press the control (05) to enter the main menu. The display will show:

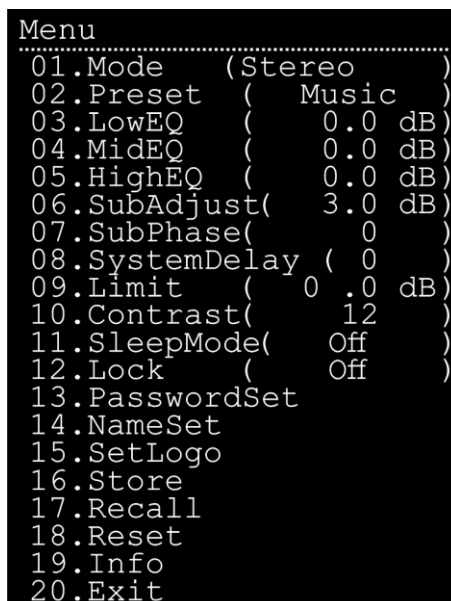

- 05) Turn the control (05) to select the desired menu.
- 06) Press the control (05) to open the menu.
- 07) Turn the control (05) to set values/choose options.
- 08) Press the control (05) to save changes.

1. Mode

In this menu you can set the desired mode.

01) Turn the control **(05)** to select one of the 4 presets:

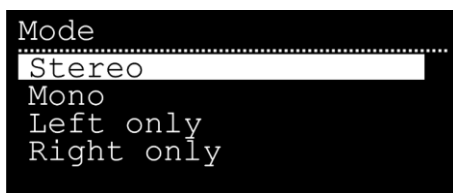

02) Press the control **(05)** to confirm.

2. Preset

In this menu you can set the desired preset.

01) Turn the control **(05)** to select one of the 4 presets:



02) Press the control **(05)** to confirm.

3. Low EQ

In this menu you can set the low equalizer.

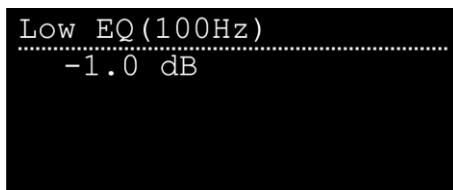

01) Turn the control **(05)** to set the low equalizer. The adjustment range is between -12 dB and 12 dB.

02) Press the control **(05)** to confirm.

4. Mid EQ

In this menu you can set the mid equalizer.

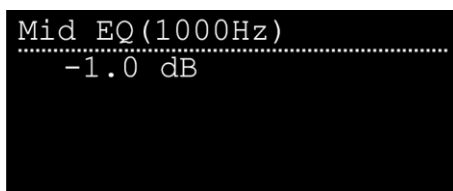

01) Turn the control **(05)** to set the mid equalizer. The adjustment range is between -12 dB and 12 dB.

02) Press the control **(05)** to confirm.

5. High EQ

In this menu you can set the high equalizer.

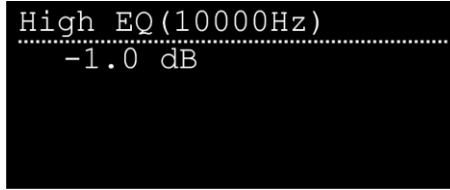

- 01) Turn the control **(05)** to set the high equalizer. The adjustment range is between -12 dB and 12 dB.
- 02) Press the control **(05)** to confirm.

6. Sub Adjust

In this menu you can adjust the subwoofer's volume level.

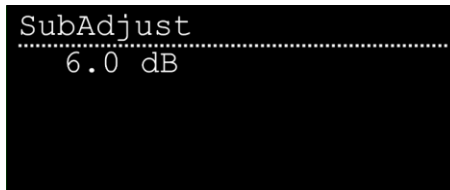

- 01) Turn the control **(05)** to set the high equalizer. The adjustment range is between -6 dB and 6 dB.
- 02) Press the control **(05)** to confirm.

7. Sub Phase

In this menu you can reverse the phase.

- 01) Turn the control **(05)** to select one of the 2 options:

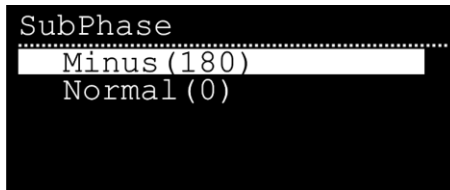

- MINUS (phase reversal)
- NORMAL (normal phase)

- 02) Press the control **(05)** to confirm.

8. System Delay

In this menu you can set the delay.

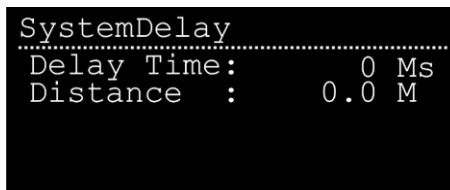

- 01) Turn the control **(05)** to set the delay. The adjustment range is between 0–6 ms. The distance will change accordingly.
- 02) Press the control **(05)** to confirm.

9. Limit

In this menu you can set the signal threshold.

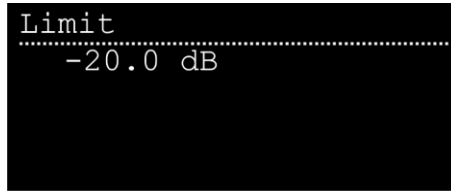

- 01) Turn the control **(05)** to set the limit. The adjustment range is between -20 dB and 0 dB.
- 02) Press the control **(05)** to confirm.

10. Contrast

In this menu you can set the display contrast.



- 01) Turn the control **(05)** to set the display contrast. The adjustment range is between 0–20, from dark to brightest.
- 02) Press the control **(05)** to confirm.



Never set the contrast to 0!
The display will turn so dark that the displayed text will be invisible.



11. Sleep Mode

In this menu you can set the sleep mode.

- 01) Turn the control **(05)** to select one of the 2 options:



- ON: The amplifier will be turned off and the device will use less electric power.
- OFF: The amplifier will remain on.

- 02) Press the control **(05)** to confirm.

12. Lock

In this menu you can set the menu lock.

- 01) Turn the control **(05)** to select one of the 2 options:



- ON: If the control is not pressed/turned for 60 seconds, the display will turn off. In order to access the main menu, turn and press the control **(05)** to insert the password.
- OFF: The menu lock is inactive.

- 02) Press the control **(05)** to confirm.

13. Password Set

In this menu you can change the password.

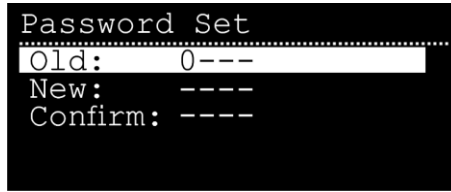

- 01) Turn and press the control **(05)** to insert the current password (**default password: 1234**).
- 02) Press the control **(05)** to confirm.
- 03) Turn and press the control **(05)** to insert the new password.
- 04) Press the control **(05)** to confirm.
- 05) Turn and press the control **(05)** to repeat/confirm the new password.
- 06) Press the control **(05)** to confirm. The device will now be reset and **any custom settings will be discarded**.

14. Name Set

In this menu you can set the device's name.

- 01) Turn the control **(05)** to select the character that needs to be edited. The NAME indicator will show its number (01–16).

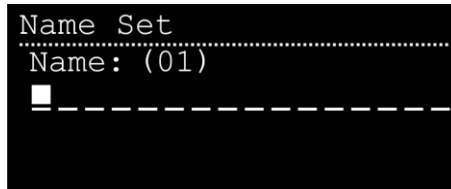

- 02) Press the control **(05)** to confirm.
- 03) Turn the control **(05)** to select a desired symbol for the character.
- 04) Press the control **(05)** to confirm.
- 05) Repeat steps 1–4 to edit the remaining characters.
- 06) When done, turn the control **(05)** until the NAME indicator shows SAVE (to save the new name).
- 07) Press the control **(05)** to confirm.

15. Set Logo

In this menu you can set whether the text or the logo will be visible during start-up.

- 01) Turn the control **(05)** to select one of the 2 options:

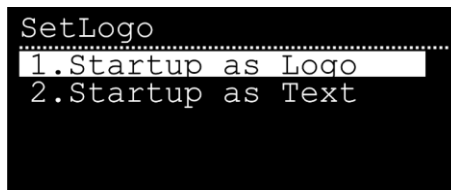

- 02) Press the control **(05)** to confirm.

16. Store

In this menu you can store the device's current settings.

01) Turn the control **(05)** to select a desired slot. There are 6 slots.

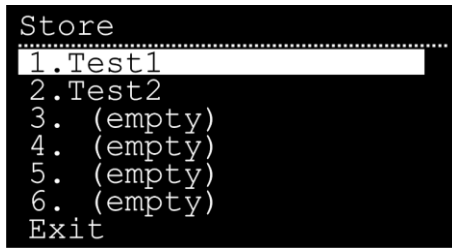

02) Press the control **(05)** to confirm.

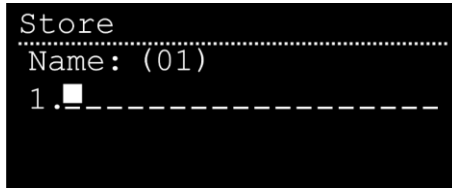

03) Turn the control **(05)** to select the character that needs to be edited. The NAME indicator will show its number (01–19).

04) Press the control **(05)** to confirm.

05) Turn the control **(05)** to select a desired symbol for the character.

06) Press the control **(05)** to confirm.

07) Repeat steps 3–6 to edit the remaining characters.

08) When done, turn the control **(05)** until the NAME indicator shows SAVE (to save the settings) or EXIT (to quit without saving).

09) Press the control **(05)** to confirm.

17. Recall

In this menu you can load the device's settings.

01) Turn the control **(05)** to select a desired setting file.

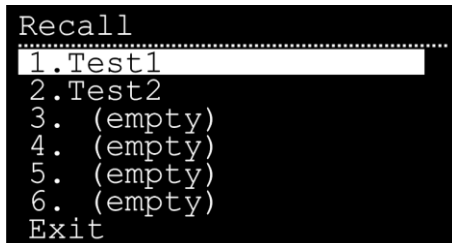

02) Press the control **(05)** to load the desired settings.

18. Reset

In this menu you can restore the factory default settings.

01) Turn the control **(05)** to select one of the 2 options:



- NO: Return to the main menu.
- YES: Restore the factory default settings.

02) Press the control **(05)** to confirm.

03) If you have chosen YES, you will need to insert the password.

04) Turn and press the control **(05)** to insert the current password.

05) Press the control **(05)** to confirm.

06) The factory default settings will be restored.

19. Info

In this menu you can view the device's software version, temperature and the total operation time.



20. Exit

Press the control **(05)** to return to the start screen.

Connection Cables

Take care of your cables, always holding them by the connectors and avoiding knots and twists when coiling them: This gives the advantage of increasing their life and reliability. Periodically check your cables. A great number of problems (faulty contacts, ground hum, discharges, etc.) are caused entirely by using unsuitable or faulty cables.

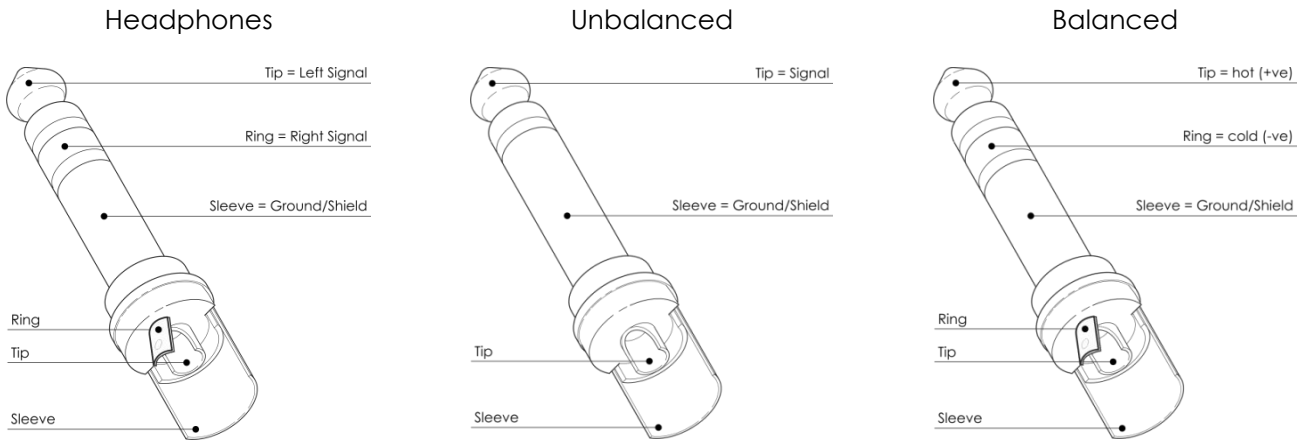

For these applications the unit provides 1/4" TRS and XLR connectors to easily interface with most professional audio devices. Follow the configuration examples below for your particular connection.

Unbalanced

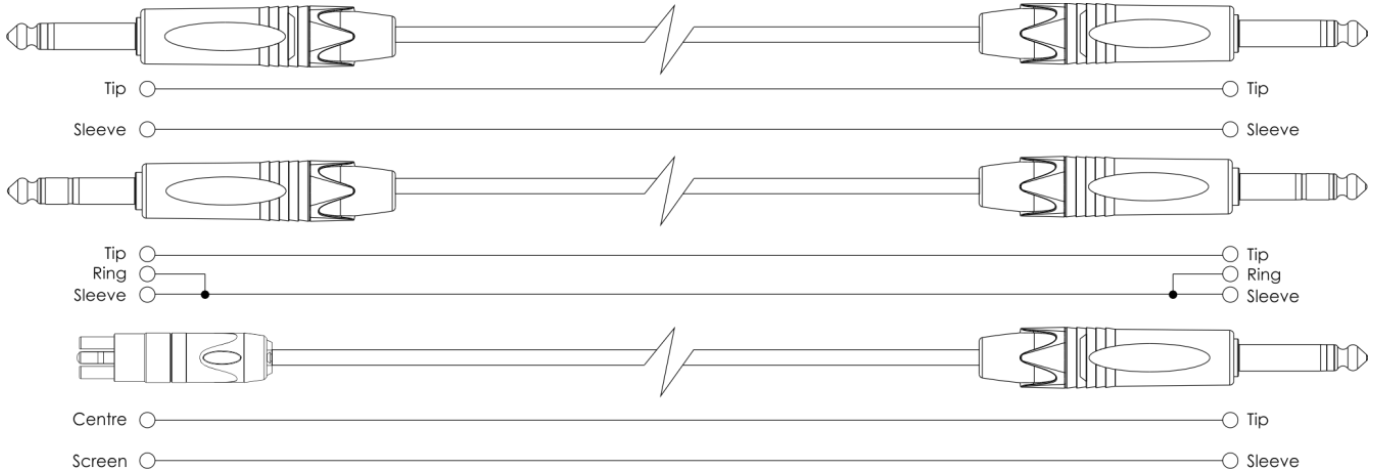

Balanced

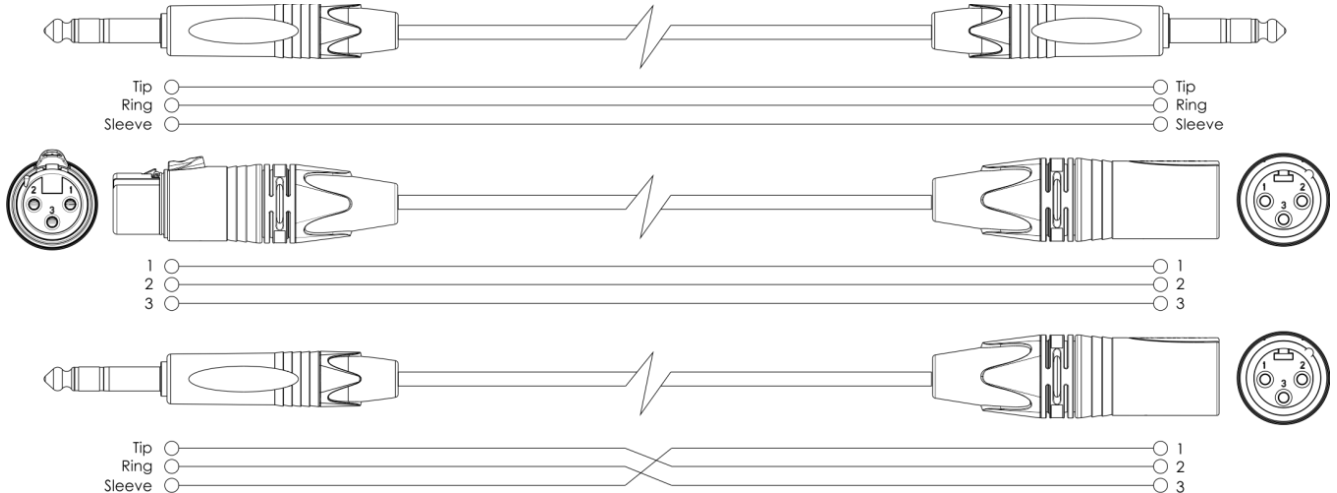

Speakon

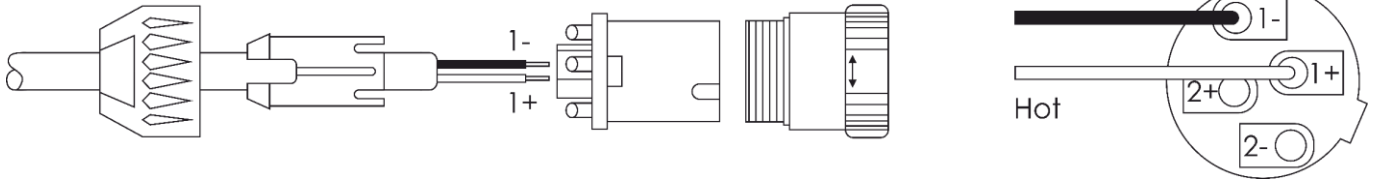

Input is a Speakon connector for connecting a speaker-level signal.
Output is a Speakon connector paralleled with the input connector, for daisy-chaining speakers.

Wiring:

Pin 1+ = Signal (+)

Pin 1- = Ground (-)

Maintenance

The Pure Club 15 with DSP requires almost no maintenance. However, you should keep the unit clean. Disconnect the mains power supply, and then wipe the cover with a damp cloth. Do not immerse in liquid. Do not use alcohol or solvents.

Keep connections clean. Disconnect electric power, and then wipe the connections with a damp cloth. Make sure connections are thoroughly dry before linking equipment or supplying electric power.

Replacing the Fuse

Power surges, short-circuit or inappropriate electrical power supply may cause a fuse to burn out. If the fuse burns out, the product will not function whatsoever. If this happens, follow the directions below.

- 01) Unplug the unit from electric power source.
- 02) Insert a screwdriver into the fuse holder. Turn the fuse holder counterclockwise. The fuse holder will come out.
- 03) Remove the used fuse. If brown or unclear, it is burned out.
- 04) Insert the replacement fuse into the holder where the old fuse was. Reinsert the fuse holder. Be sure to use a fuse of the same type and specification. See the product specification label for details.

Troubleshooting

No Sound

Always check if all the cables and cords are connected. Always turn off power to the area before checking the wires, to prevent electric shock.

If everything works properly and there is still no sound, revisit the manufacturer's instructions to make sure they were followed during installation. If everything was installed correctly and there is still no sound, you may want to consider bringing in a professional to take a look at your speaker.

If the speakers do not operate properly, refer servicing to a technician.

Suspect three potential problem areas as: the power supply, the fuse and the speakers.

01) Power supply. Check if the unit is plugged into an appropriate power supply.

02) The fuse. Replace the fuse. See page 18 for replacing the fuse.

03) The speakers. Return the Pure Club to your DAP Audio dealer.

04) If all appears to be O.K., plug the unit in again.

05) If you are unable to determine the cause of the problem, do not open the Pure Club, as this may damage the unit and the warranty will become void.

06) Return the device to your DAP Audio dealer.

Sound Warping

If the sound coming out of your speaker is loud enough, but seems to be warped or distorted, your treble or bass levels may need to be adjusted.

If there are not many pieces of furniture in the room and the floor has no carpet or rug, then you will most likely have to set your treble to minus. With very little in the room to absorb the sound, too much treble can make the sound bounce off of fixtures in the room, making it tinny sounding.

With the bass, if the speaker is too close to a wall and is not aimed properly, then you will need to set the bass to minus, to stop the low tones from bouncing off of the walls or large pieces of furniture.

Product Specifications

Model:	Pure Club 15 with DSP
Power supply:	120/230 V AC, 50/60 Hz
Power amp low:	400 W RMS @ 8 Ω
Power amp high:	2 x 150 W RMS @ 8 Ω
Speaker low:	15", 2" Voice coil
Speaker high:	8/1" passive vented PA Satellite speaker system
Frequency response (-3 dB):	40 Hz–20 kHz
S/N ratio:	>103 dBr
Crossover frequency:	125 Hz, 24 dB/Oct BW
Dispersion satellite (HxV):	90° x 60°
Dispersion subwoofer (HxV):	360° x 180°
Sensitivity satellite (full space):	95 dB / W / m
Sensitivity subwoofer (half space):	102 dB / W / m
SPL peak satellite @ 1 m:	116,8 dB
SPL peak subwoofer @ 1 m:	128 dB
Protection:	Short circuit, temperature, overload
Audio connector:	2 x combo 3-pin XLR/6,3 mm jack IN; 2 x 3-pin XLR OUT; 2 x Speakon NL4 OUT; RCA L/R IN
Mains connector:	Pro power connector IN/OUT
Housing:	12-mm Birch Plywood
Color:	Black, scratch resistant
Mounting:	35-mm pole mount
Fuse (subwoofer):	T5AL/250V
Dimensions (satellite):	265 x 250 x 420 mm (LxWxH)
Dimensions (subwoofer):	625 x 454 x 570 mm (LxWxH)
Weight (satellite):	2 x 6,88 kg
Weight (subwoofer):	28,82 kg

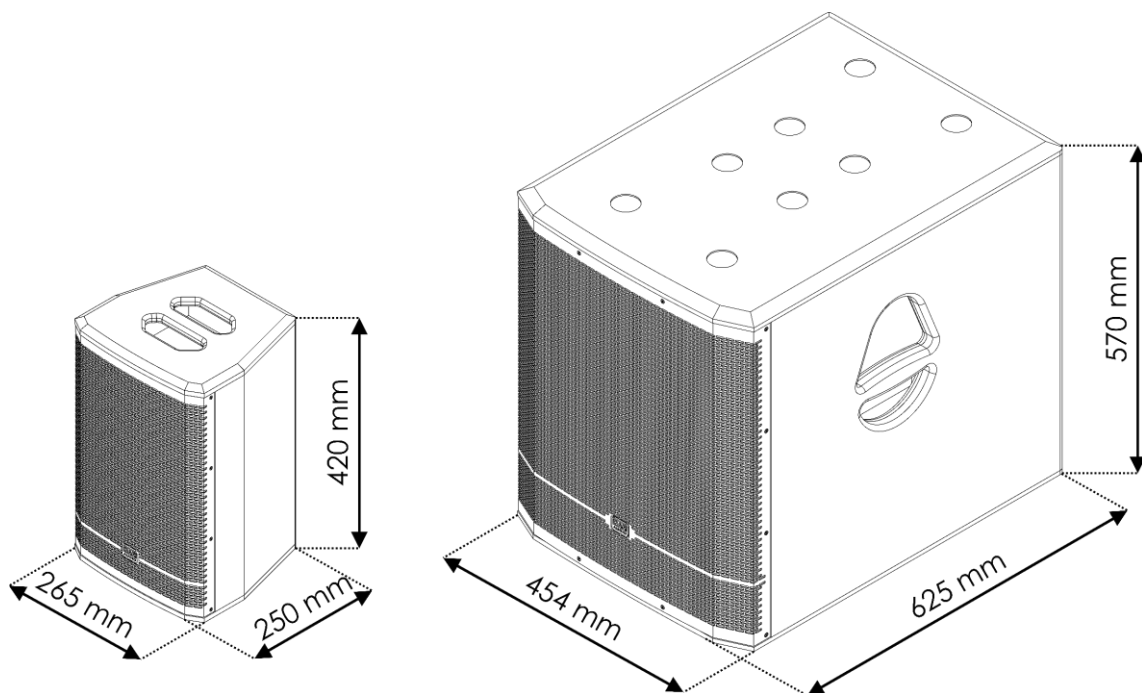

Design and product specifications are subject to change without prior notice.



Website: www.Dap-audio.info

Email: service@highlite.com



©2020 DAP Audio